

► SKIMMER 17,5L PISCINA PREF. / SKIMMER 17,5L PREF. POOL



11309



11311

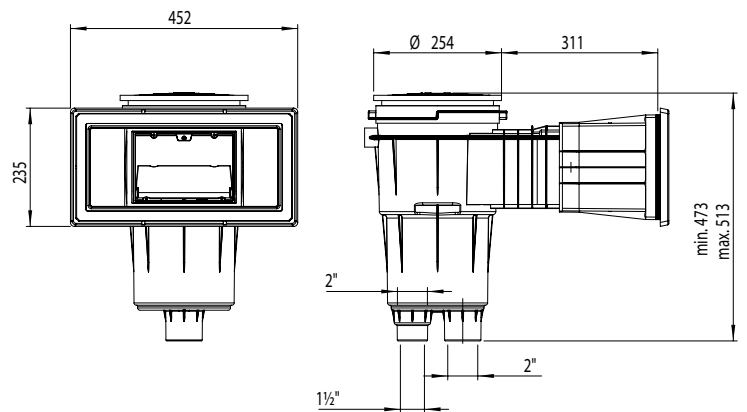
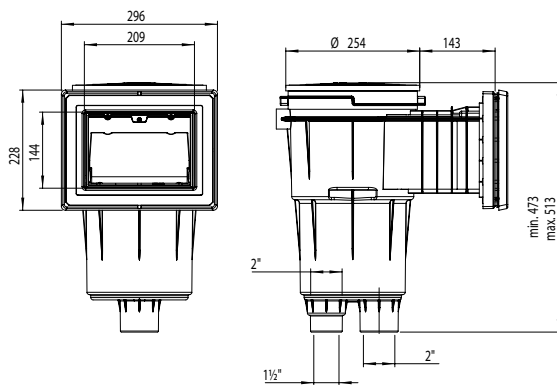











DESCRIPCIÓN DEL PRODUCTO / PRODUCT DESCRIPTION

Suministrados con juntas adhesivas, bridas y tornillos. Todos los skimmers de la gama tienen tratamiento UV en las partes que no quedan enterradas. Fabricados en ABS blanco, con flotador de compuerta y tapón para regulación de caudal. Conexión inferior de aspiración: rosca interior 1 1/2", exterior 2". Conexión simultánea al sumidero: Ø interior 50. Conexión superior de evacuación de agua sobrante Ø 40. Cesto recogehojas fijado a la base mediante cierre por bayoneta. Caudal recomendado 7,5 m³/h. Se recomienda instalar un skimmer por cada 25 m² de superficie de lámina de agua.

Supplied with adhesive gaskets, flanges, and screw kit. All skimmer parts exposed are UV resistant. Recommended flow 7500 l/h. In white ABS with silent weir flap and flow regulation plug. 1 1/2" female – 2" male suction connections. Ø 50 mm. solvent connection also provided. Overflow connection Ø 40 mm. Basket secured to base with bayonet fixing.

► CARACTERÍSTICAS TÉCNICAS / TECHNICAL CHARACTERISTICS

CARACTERÍSTICAS CHARACTERISTICS	11309	11310	11311	11317
Tipo de boca Type of throat				
Forma tapa Lid form				
Conexión superior Top connection	Ø 40			
Caudal recomendado Recommended flow rate	7,5 m ³ /h			
Superficie recomendada Recommended surface	cada 25 m ² every 25 m ²			
Insertos Inserts	✓	✓	✓	-
Colores Colours	  CL090  CL129  CL144			

► LOGÍSTICA / LOGISTICS

EMBALAJE Y PALETIZADO / PALLETIZED AND PACKAGING						
Código - Code	11309 - 11310			11311 - 11317		
Medidas caja (mm) - Box sizes (mm)	a	b	c	a	b	c
		300	480	430	460	600
Unidades / Caja - Units / Box	1			1		
Volumen / Caja (m ³) - Volume / Box (m ³)	0,062			0,132		
Peso / Caja (Kg) - Weight / Box (Kg)	5,3			6,52		
Medidas palet (mm) - Pallet sizes (mm)	a	b	c	a	b	c
	1000	1200	2400	1000	1200	2400
Unidades / Palet - Units / Pallet	35			16		
Volumen / Palet (m ³) - Volume / Pallet (m ³)	2,88			2,88		
Peso / Palet (Kg) - Weight / Pallet (Kg)	194,06			112,88		

► CAJA / BOX

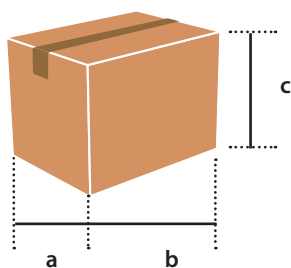

► PALET / PALLET

